

EST



2008

ORBITAL

- LIFTS LIMITED -



AESTHETIC BROCHURE

MADE IN ITALY





ANOTHER DEFINITION OF THE PERFECT

As a spectacular combination of the cutting-edge hydraulic technology and the prominent Italian aesthetics, Orbital Lifts Ltd lives up to every strict standard of European Engineering in particular and of the world's lift in general.

As luxurious and elegant as a lotus, Orbital Lifts Ltd embodies the summit of the noble art as well as the advanced lift manufacturing. You will find another definition of the Perfect when it comes to Orbital Lifts Ltd.

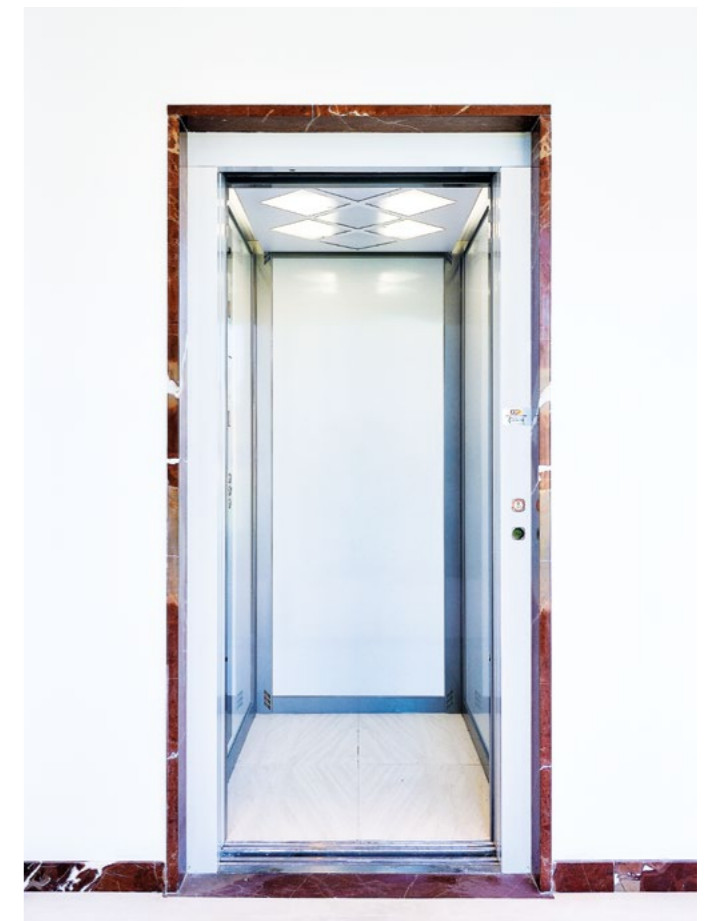



FIRST CLASS PRODUCTS

All of our components and materials of Orbital Lifts Ltd are carefully selected to ensure natural resources are used in a manner which does not adversely affect the environment.

All supplier-side items used in our production methodology are selected using strict criteria.

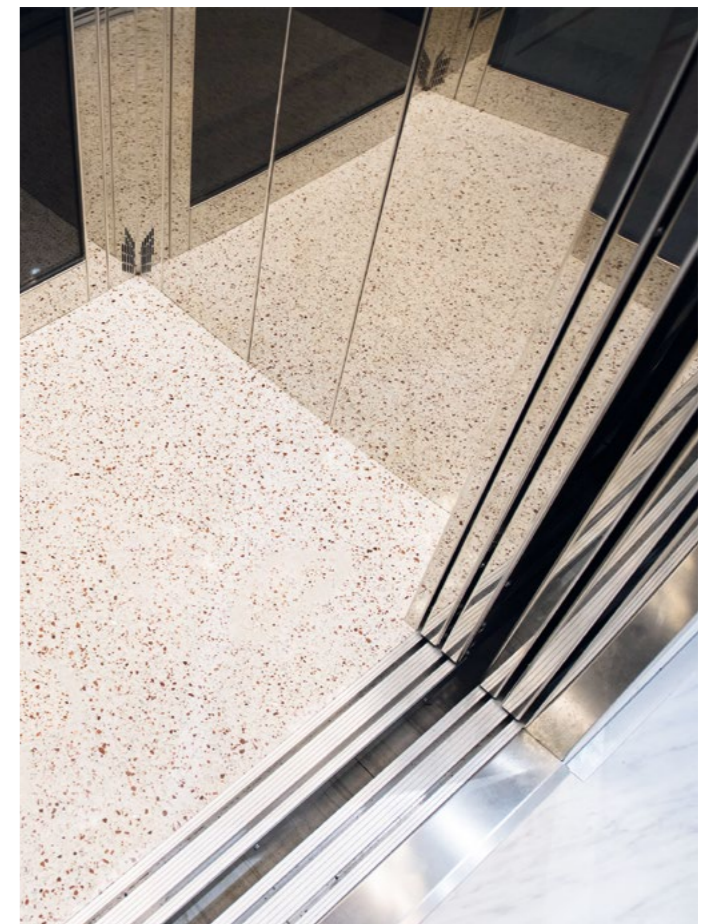





BRILLIANCE

Orbital Lifts Ltd offers beautiful stainless steel, aluminum, glass, real wood veneer laminate; high gloss lacquered finishes, etc.

And, our artistic nature, creativity and vast experience in using these materials give our lifts an unrivalled depth and uniformity to them. A thorough understanding of the materials we use in our production methods and a keen eye for detail ensures the material attributes are as uniformed as possible, as we use very strict criteria in the selection process of our materials.

The color, grain and moisture content of the wood must meet the very stringent quality standards required for Orbital Lifts Ltd in order to make it to the production process.





MODERNA CABIN

NEW STYLE LOOK



- Flush Cop
 - Flush Profiles
- Standard Finishes**
- Walls any Skinplate
 - Cop and Profiles (F41PPS and F12PPS)
- Other Finishes available**
- Skinplates
 - Brushed or Polished Stainless Steel
 - RAL Painted
 - Steelcolor Special Stainless Steel

CLASSICA CABIN

THE GREAT CLASSIC



- Raised Profiles and Cop
 - Skirting
- Standard Finishes**
- Walls any Skinplate
 - Cop and Profiles (F41PPS and F12PPS)
- Other Finishes available**
- Skinplates
 - Brushed or Polished Stainless Steel
 - RAL Painted
 - Steelcolor Special Stainless Steel

CEILINGS

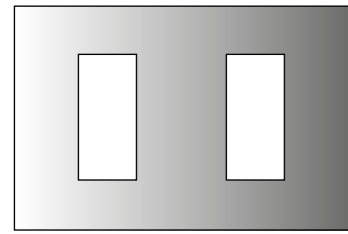

SQUARE



LED SPOTLIGHTS

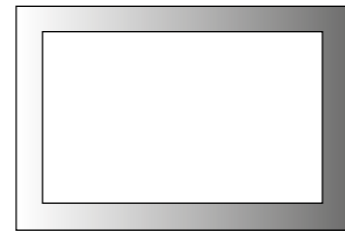

REGULAR

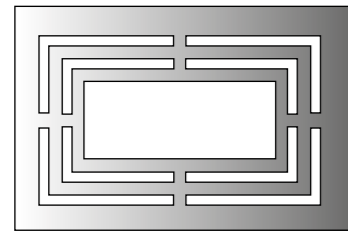

LABIRINT

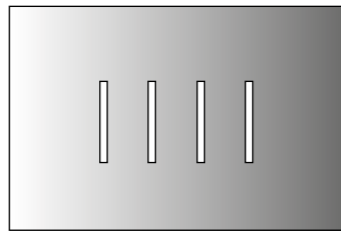

LINE

Standard Finishes

- F41PPS, F12PPS and A490PP.

Other Finishes available

- Skinplates
- Brushed or Polished Stainless Steel
- RAL Painted
- Steelcolor Special Stainless Steel

HANDRAILS

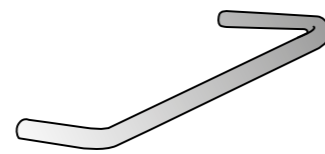
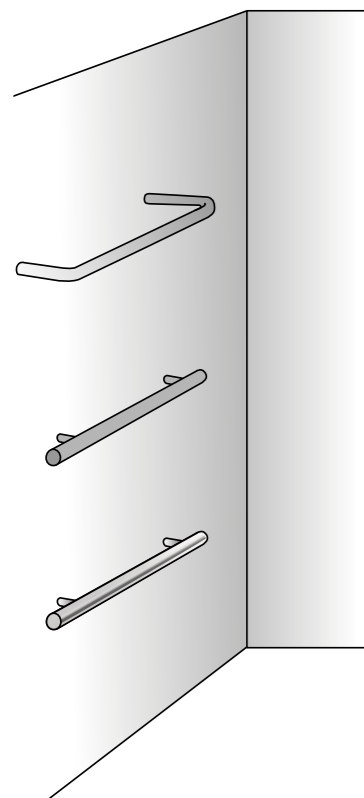

CURVED
(BRUSHED STAINLESS STEEL)

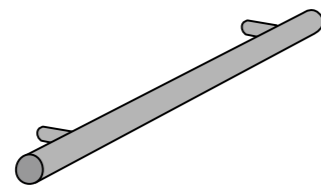

ALUMINIUM PAINTED
RAL GREY

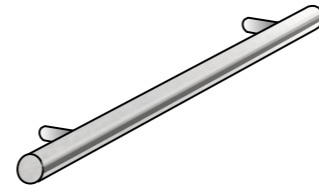

BRUSHED OR POLISHED
STAINLESS STEEL

All images shown are for illustration purpose only and may not be an exact representation of the product.

CAR OPERATING PANELS



DISPLAYS

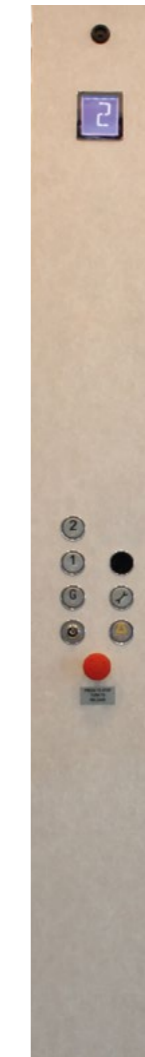

MODEL VERTICAL

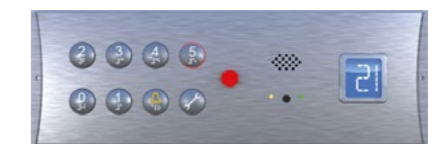

MODEL HORIZONTAL

Finishes

- Skinplates (standard F41PPS and F12PPS)
- Galvanized
- Stainless steel (brushed or polished)
- RAL painted
- Steelcolor Special Stainless Steel

OTHER ACCESSORIES



BLACK PHONE STANDARD



KEY SWITCHES



E-BUTTON



EMERGENCY

PHONE DIALER, PHONE DIALER GSM

All images shown are for illustration purpose only and may not be an exact representation of the product.



STEEL STRUCTURE SHAFT



The cladding for the structures can be sheet steels or laminated glass.



TRANSPARENT ETCHED NEUTRAL STOP-SOL (SMOKE/BRONZE) WHITE MILK BRONZE SMOKE

All images shown are for illustration purpose only and may not be an exact representation of the product.

LANDING DOORS

SWING DOORS



ALUMINIUM

Frame and panel Finishes

- Aluminum anodized
- RAL painted (orange peel or polished/matt smooth)
- Natural transparent Glass or colored glass

Accessories included

- RYOBI door opener
- Style short handle



VILLA

Frame Finishes

- Brushed or Polished Stainless Steel
- RAL painted

Panel Finishes

- Natural transparent glass

Accessories included

- RYOBI door opener
- Villa stainless steel handle



All images shown are for illustration purpose only and may not be an exact representation of the product.



FOLDING DOOR

(OPTIONAL WITH SWING LANDING DOOR)

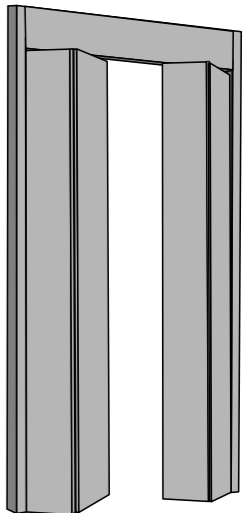
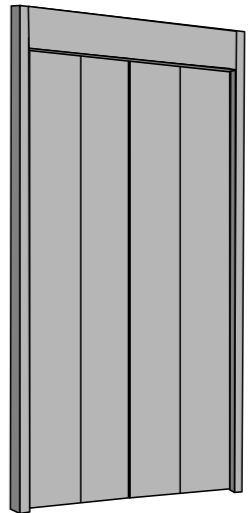
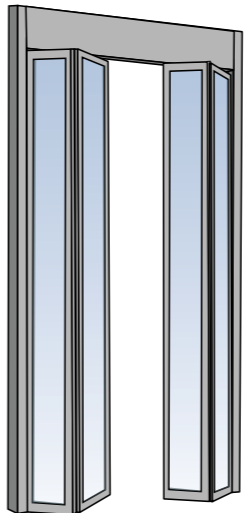
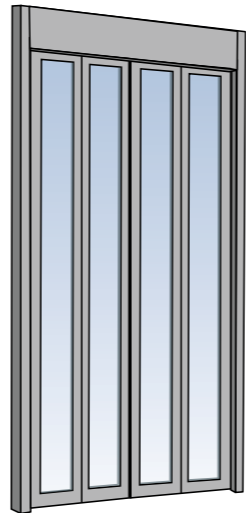

PANORAMIC

NO WINDOW

Finishes available
Brushed or Polished Stainless Steel, Skinplate or RAL painted.

SWING DOOR HANDLES

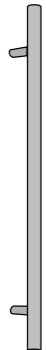
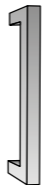
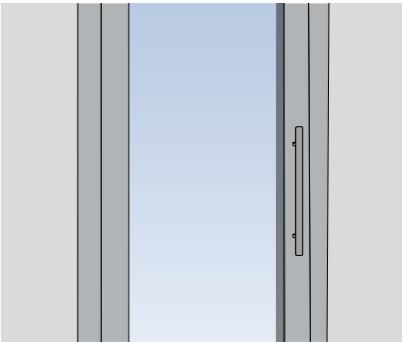
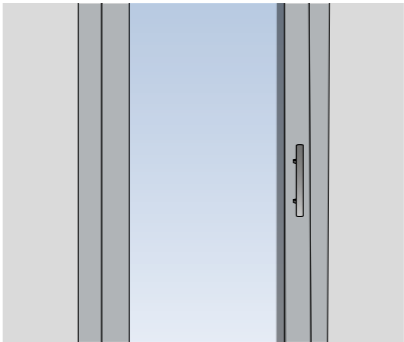
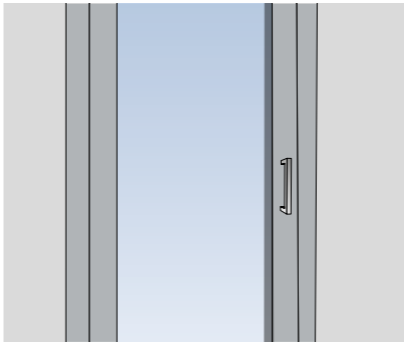

QUADRA IN BRUSHED STAINLESS STEEL

STYLE SHORT BRUSHED OR POLISHED STAINLESS STEEL

STYLE LONG BRUSHED OR POLISHED STAINLESS STEEL

All images shown are for illustration purpose only and may not be an exact representation of the product.

LANDING DOORS

SWING DOORS



CLASSIC DOOR

Semi-automatic metal door available in a plain version or with glass, available in one or two panels, painted in the RAL range colours.



SMALL WINDOW

First measure available among windows. Allows the possibility to see the car at landings.

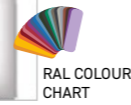

LARGE WINDOW

Intermediate window dimension, allows a greater passage of light inside the car.

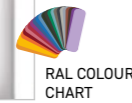

GLAZED DOORS

Panoramic size window, allows a full vision of the car. This type of doors is used frequently in units with metallic structure.

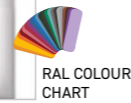

DOUBLE GLAZED DOORS

Door that allows passage of very bright light, with its two separate windows. This solution is a viable alternative of the panoramic door.

LANDING DOORS

SLIDING DOORS



SIDE OPENING



CENTRE OPENING



THREE PANELS



FRAMED GLASS



FULL GLASS



DIAMOND

Finishes available

Skinplates, Brushed or Polished Stainless Steel, RAL painted or Steelcolor Special Stainless Steel.

SLIDING DOORS

TWO PANELS



SLIDING DOORS

THREE PANELS



STANDARD MATERIALS

FLOORING

LINOLEUM



WALLS AND PANELS

ITALIAN SKINPLATES

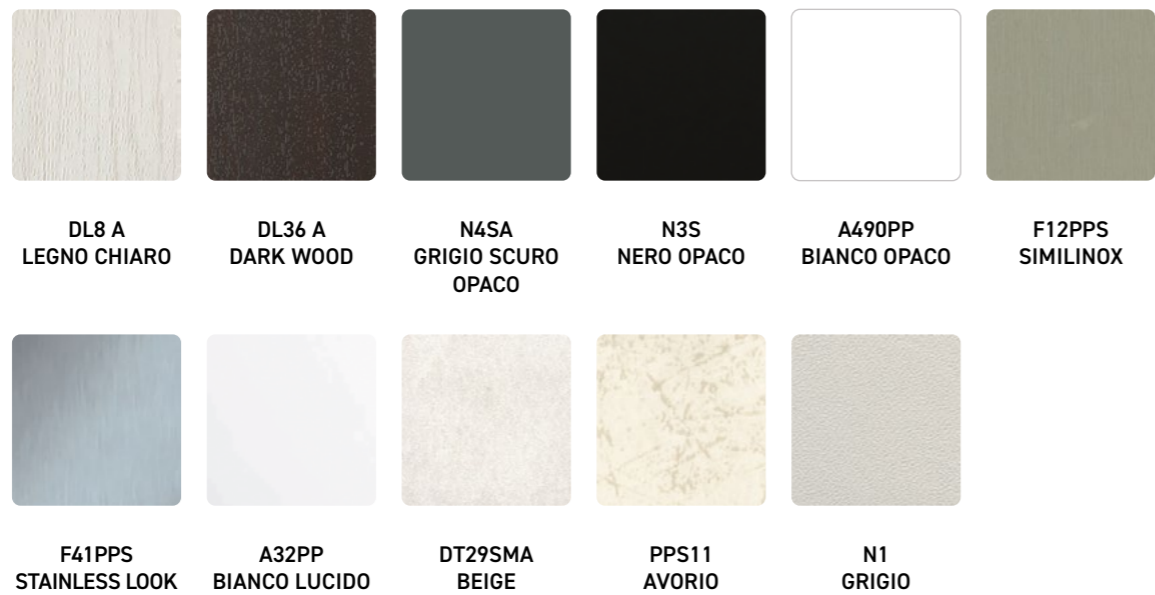

OPTIONAL MATERIALS

WALLS (ONLY FOR CLASSICA CABIN - NOT SUITABLE FOR ANGLES)

PREMIUM ITALIAN LAMINATE



PLASTIC LAMINATE MATERIC EXPRESSION

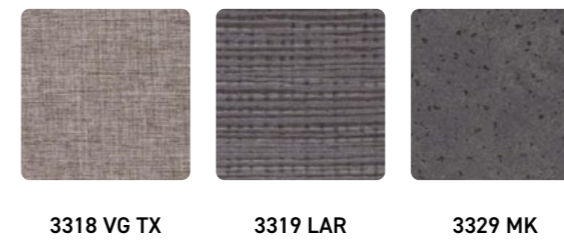

PLASTIC LAMINATE WOODS



FLOORING

GRANIT

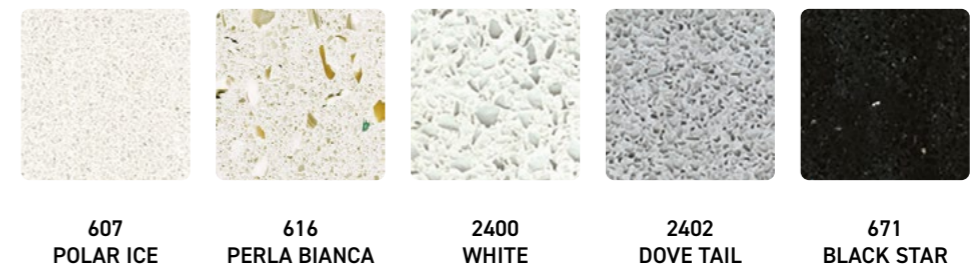

All images shown are for illustration purpose only and may not be an exact representation of the product.

All images shown are for illustration purpose only and may not be an exact representation of the product.

OPTIONAL MATERIALS

WALLS AND PROFILES

STAINLESS STEEL



POLISHED
STAINLESS STEEL



STAINLESS STEEL
QUADRETTO



BRUSHED
STAINLESS STEEL

SPECIAL STAINLESS STEEL



SC 147



SC 111

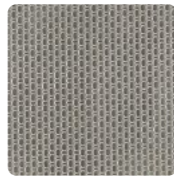

LINO LUCIDO

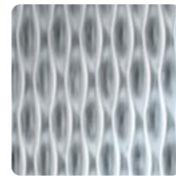

5WL LUCIDO

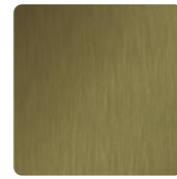

ORO SB



PIOGGIA BRONZO



STRIPES BRONZO



DOTS BRONZO

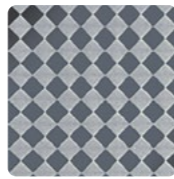

SC 1077 D



QUADRO ORO

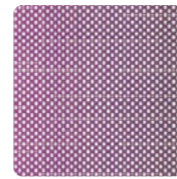

LINO ROSSO

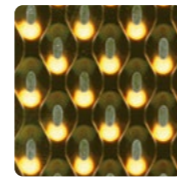

PERLA ORO



GOCCIA BLU



PELLE VERDE



RETE BLU

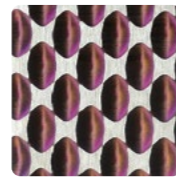

GOCCIA ROSSO



All images shown are for illustration purpose only and may not be an exact representation of the product.



ORBITAL
- LIFTS LIMITED -

07903 915 342
Unit 10, Precision 4 Business Park, Eurolink
Bingham Road, Sittingbourne, Kent ME10 3FZ

Company registered in England & Wales.
Company registration number 06562181.